

Model No.: FP-1630-005, Fabry Perot Diode Laser

Description: The FP-1630-005 is a high power InGaAsP/InP Fabry Perot diode laser. The chips are mounted in a 9mm TO-can. The diode laser operates spatially single mode and longitudinally multimode.

Characteristics: The characteristics are measured at 25°C operation temperature.

Parameter	Symbol	Unit	min.	typ.	max.
Center Wavelength	λ_c	nm	1610	1630	1650
Spectral Width	$\Delta\lambda$	nm		2	
Temperature Coefficient	$\Delta T/\Delta\lambda$	m/K		0.4	
Output Power	P_{opt}	mW	5		
Slope Efficiency	η	mW/mA	0.05	0.09	0.18
Threshold Current	I_{th}	mA	8	19	25
Operation Current @ 5mW	I_{op}	mA	40	49	80
Operation Voltage @ 5mW	V_{op}	V	0.8	1.1	1.6
Chip Length	L_c	μm	300	350	400
Emitter width	W_c	μm		3	
Beam Divergence (FWHM)	$\theta_{ }$	deg.		28	
Beam Divergence \perp (FWHM)	θ_{\perp}	deg.		28	
Polarization				TE	
Mode Structure			fundamental transverse mode		

Laser Mount: 9mm TO-can with monitor diode

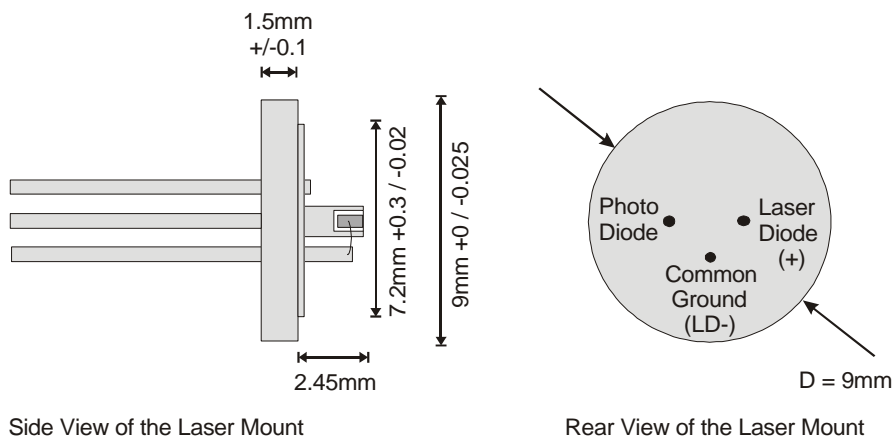

Document: <http://data.sacher.de/FPD/FP1630005.pdf>
 Note: Specification are subject to change without further notice

